



DETKI OCHRANIACZE

KABAT 



MADE IN **POLAND**

NASZ EKSPORT

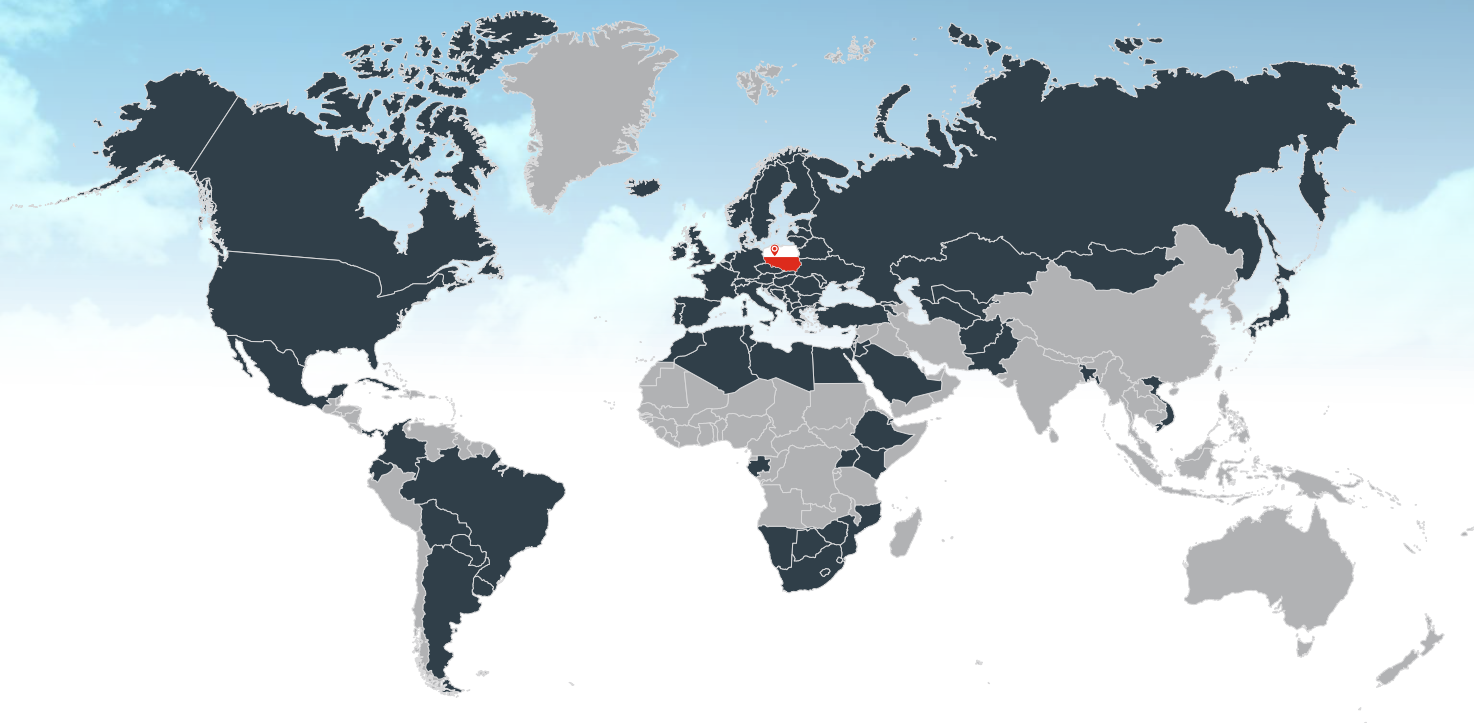

KABAT TYRE to polski producent opon rolniczych, przemysłowych oraz opon pełnych do wózków widłowych, dętek, ochraniaczy, profili gumowych (do budownictwa i stolarki otworowej), mieszanek gumowych oraz szeroko pojętych technicznych wyrobów z gumy. Firma KABAT została założona w 1983 roku i od początku swojego istnienia jest ona biznesem rodzinnym. Właścicielem firmy jest Andrzej Kabat.

Początkowo firma była małym zakładem rzemieślniczym, w którym naprawiano opony i dętki. Powierzchnia zakładu wynosiła wtedy 21m². Obecnie firmę tworzy prawie 1000 osób, a powierzchnia zabudowana hal w obu zakładach (Budzyń i Bolechowo) to 65 104 m².

Mocne strony firmy to szybka obsługa, wysoka jakość wyrobów i świadczonych usług. Zaplecze techniczne składa się z czterech linii mikserów z walcarkami, kalandrów, wyciązarek i pras hydraulicznych. KABAT TYRE dysponuje profesjonalnym Działem Technologii oraz doświadczoną i wyspecjalizowaną kadrą, co daje gwarancję najwyższej jakości produktów. Dział Technologii składa się z kilku obszarów, tj. konstrukcji wyrobu, inżynierii procesu oraz technologii wyrobu. Każdy nowy wyrób dostosowywany jest do indywidualnych wymogów i potrzeb klienta.

KABAT TYRE to lider w produkcji dętek w Europie oraz jeden z czołowych producentów dętek na świecie. Od 2006 roku firma funkcjonuje w oparciu o zintegrowane systemy zarządzania ISO 9001:2015 (produkcja), ISO 14001:2015 (ochrona środowiska), PN-N 45001:2018 (bezpieczeństwo i higiena pracy), certyfikowane przez Bureau Veritas. Certyfikat NATO NCAGE daje przedsiębiorstwu możliwość wzięcia udziału w przetargach dla wojsk różnych krajów.

PN-N 45001
BUREAU VERITAS
Certification



ISO 14001
BUREAU VERITAS
Certification



ISO 9001
BUREAU VERITAS
Certification



DO SAMOCHODÓW CIĘŻAROWYCH I AUTOBUSÓW

		KOD	ROZMIAR	DODATKOWY OPIS	ZAWÓR	IL. W KARTONIE
15"	1	DET077	7.00-15	7.00R15	V3.04.10	20
	2	DET095	7.00-15	7.00R15	TR-75A	20
	3	DET081	7.50-15	7.50R15	V3.02.18	20
	4	DET074	7.50/8.15-15	7.50/8.15R15	TR-75A	20
	5	DET073	8.15-15	8.15R15	TR-177A	20
	6	DEC004	8.25-15	8.25R15	V 3.02.8	15
	7	DEC133	8.25-15	8.25R15	V3.04.5	15
	8	DEC030	8.25-15	8.25R15	TR-75A	15
	9	DEC001	8.40-15	8.40R15	TR-15	15
	10	DEC314	10.00-15	10.00R15	V3.02.8	15
	11	DEC421	10.00-15	10.00R15	TR-78A	12
	12	DEC051	12.5/60-15	12.5/60R15	V3.02.5	12
16"	13	DEC003	7.50-16	7.50R16	V3.02.18	18
	14	DEC102	7.50-16	7.50R16	V3.02.8	18
	15	DER264	7.50-16	7.50R16	TR-75A	18
	16	DEC412	7.50-16	7.50R16	TR-78A	18
	17	DEC363	7.50-16	7.50R16	TR-177A	18
	18	DEC229	8.25-16	8.25R16	V3.04.5	12
	19	DEC310	8.25-16	8.25R16	TR-75A	12
	20	DEC359	8.25-16	8.25R16	TR-78A	12
	21	DEC422	8.25-16	8.25R16	TR-177A	12
	22	DEC006	9.00-16	9.00R16	V3.02.8	12
	23	DER164	9.00-16	9.00R16	TR-177A	12
	24	DER356	9.00-16	9.00R16	TR-75A	12
	25	DEC155	10.5-16	10.5R16	V3.02.8	12
	26	DEC473	10.5-16	10.5R16	TR-177A	12
	27	DEC423	11.00-16	11.00R16	TR-177A	10
	28	DEC085	11.00/12.00-16	11.00/12.00R16	V3.04.10	10
	29	DEC086	13.00-16	13.00R16	V3.04.10	10
16.5"	30	DEC154	10.5-16.5	10.5R16.5	V3.06.8	12
17.5"	31	DEC336	8.5R17.5	8.5R17.5	VS3.21.1	15
	32	DEC173	215/75-17.5	215/75R17.5	V3.02.18	15
18"	33	DEC014	12.00-18	12.00R18	V3.02.8	7
	34	DEC393	12.00-18	12.00R18	PK-5A	7
	35	DEC015	13.00-18	13.00R18	V3.02.8	6
	36	DEC244	13.00-18	13.00R18	PK-5A	5
	37	DEC592	15.5/65-18	15.5/65R18	TR-175A	6
20"	38	DEC149	6.50/7.00-20	6.50/7.00R20	V3.04.5	15
	39	DEC002	6.50/7.00-20	6.50/7.00R20	V3.02.18	15
	40	DET121	6.50/7.00-20	6.50/7.00R20	TR-75A	15
	41	DEC323	6.50/7.00-20	6.50/7.00R20	TR-177A	15
	42	DEC191	7.50-20	7.50R20	V3.02.8	15
	43	DEC193	7.50-20	7.50R20	V3.04.5	15
	44	DET122	7.50-20	7.50R20	TR-75A	15
	45	DEC226	7.50-20	7.50R20	TR-177A	15
	46	DEC018	7.50-20	7.50R20	V3.06.3	15
	47	DEC005	8.25-20	8.25R20	V3.02.10	12
	48	DEC475	8.25-20	8.25R20	TR-78A	12
	49	DEC355	8.25-20	8.25R20	TR-177A	12
	50	DEC007	9.00-20	9.00R20	V3.02.11	10
	51	DEC055	9.00-20	9.00R20	V3.06.8	10
	52	DEC082	9.00-20	9.00R20	V3.04.5	10
	53	DEC447	9.00-20	9.00R20	TR-75A	10
	54	DEC416	9.00-20	9.00R20	TR-78A	10
	55	DEC476	9.00-20	9.00R20	TR-175A	10
	56	DEC267	9.00-20	9.00R20	TR-177A	10
	57	DEC008	10.00-20	10.00R20	V3.02.14	10
	58	DEC045	10.00-20	10.00R20	V3.06.8	10



		KOD	ROZMIAR	DODATKOWY OPIS	ZAWÓR	IL. W KARTONIE
20"	59	DEC083	10.00-20	10.00R20	V3.04.5	10
	60	DEC182	10.00-20	10.00R20	V3.02.5	10
	61	DEC206	10.00-20	10.00R20	TR-87	10
	62	DEC376	10.00-20	10.00R20	TR-78A	10
	63	DEC356	10.00-20	10.00R20	TR-177A	10
	64	DEC009	11.00-20	11.00R20	V3.02.14	8
	65	DEC084	11.00-20	11.00R20	V3.04.5	8
	66	DEC048	11.00-20	11.00R20	V3.06.18	8
	67	DEC417	11.00-20	11.00R20	TR-78A	8
	68	DEC357	11.00-20	11.00R20	TR-177A	8
	69	DEC424	11.00-20	11.00R20	TR-179A	8
	70	DEC050	12.00-20	12.00R20	V3.02.14	6
	71	DEC052	12.00-20	12.00R20	V3.06.8	6
	72	DEC174	12.00-20	12.00R20	V3.06.17	6
	73	DEC270	12.00-20	12.00R20	TR-78A	6
	74	DEC358	12.00-20	12.00R20	TR-177A	6
	75	DEC320	12.00-20	12.00R20	TR-179A	6
	76	DEC390	1200/500-508	1200/500R508	PK-5A	6
	77	DEC017	14.00-20	14.00R20	V3.06.8	6
	78	DEC057	14.00-20	14.00R20	V3.02.14	6
	79	DEC101	14.00-20	14.00R20	V3.04.5	6
	80	DEC360	14.00-20	14.00R20	TR-177A	6
	81	DEC249	14.00-20	14.00R20	TR-179A	6
	82	DEC271	14.00-20	14.00R20	TR-78A	6
	83	DEC250	14.5R20	14.5R20	V3.02.16	6
	84	DEC031	16.00-20	16.00R20	V3.06.8	5
	85	DEC425	16.00-20	16.00R20	TR-179A	5
86	DEC295	18.0/70-20	18.0/70R20	V3.04.5	5	
87	DER354	20.0/70-20	20.0/70R20	V3.06.8	5	
21"	88	DEC260	15.00-21	15.00R21	V590	2
	89	DEC232	15.00-21	15.00R21	TRJ-1175C	2
	90	DEC387	1200/400-533	1200/400R533	PK-5A	3
	91	DEC480	1220/400-533	1220/400R533	V3.02.14	5
	92	DEC595	425/85-21	425/85R21	V3.06.8	5
93	DEC389	1300/500-533	1300/530R533	PK-5A	2	
22"	94	DEC188	11.00-22	11.00R22	V3.06.5	7
22.5"	95	DEC033	9.00-R22.5	9.00RR22.5	V3.06.3	12
	96	DEC034	10.00-R22.5	10.00RR22.5	V3.06.2	10
	97	DEC035	11.00-R22.5	11.00RR22.5	V3.06.3	8
	98	DEC036	12.00-R22.5	12.00RR22.5	V3.06.2	8
	99	DEC037	13.00-R22.5	13.00RR22.5	V3.06.2	6
	100	DEC038	15.00-R22.5	15.00RR22.5	V3.06.2	5
	101	DER392	315/80R22.5	315/80R22.5	VS3.21.1	6
102	DER395	385/65R22.5	385/65R22.5	VS3.21.1	5	
24"	103	DEC124	12.00-24	12.00R24	V3.06.8	6
	104	DEC097	12.00-24	12.00R24	V3.02.15	6
	105	DEC265	12.00-24	12.00R24	TR-78A	6
	106	DEC325	12.00-24	12.00R24	TR-179A	6
	107	DEC021	13.00-24	13.00R24	V3.02.14	6
	108	DEC428	13.00-24	13.00R24	TR-78A	6
	109	DEC075	13.00-24	13.00R24	TR-177A	6
	110	DEC013	14.00-24	14.00R24	V3.04.5	6
	111	DEC099	14.00-24	14.00R24	V3.04.22	6
	112	DEC109	14.00-24	14.00R24	V3.02.14	6
	113	DEC058	14.00-24	14.00R24	TR-177A	6
	114	DEC426	14.00-24	14.00R24	TR-179A	6
	115	DER137	16.00-24	16.00R24	V3.04.22	4
	116	DEC177	16.00-24 HD	16.00R24 HD	V3.02.17	3
	117	DER305	21.3-24	21.3R24	V3.02.15	2
	118	DEC450	21.3-24	21.3R24	TR-177A	2
25"	119	DEC169	18.00-25	18.00R25	V3.02.17	3
28"	120	DEC494	21.00-28	21.00R28	V3.02.17	3

DO SAMOCHODÓW OSOBOWYCH

		KOD	ROZMIAR	DODATKOWY OPIS	ZAWÓR	IL. W KARTONIE
10"	1	DET044	ER10 145-10	ER10 145R10	TR-13	50
	2	DEO001	DR12 125/135-12	DR12 YK-12 125/135R12	TR-13	50
12"	3	DEO066	DR12 125/135-12	DR12 125/135R12	TR-15	50
	4	DEO002	ER12 145/155-12	ER12 YK-12 145/155R12	TR-13	35
	5	DEO070	FR12 155/165/175/70-12	FR12 155/165/175/70R12	TR-13	35
13"	6	DEO003	ER13 135/70-13; 145/70-13	ER13 135/70R13; 145/70R13	TR-13	40
	7	DEO004	145/70;155/70-13	145/70;155/70R13	TR-13	35
13"	8	DEO012	FR13 165/70-13	FR13 YK-13 165/70R13	TR-13	35
	9	DEO005	175/70-13	YKR13-02 175/70R13	TR-13	30
	10	DEO024	6.00/6.50-13	6.00/6.50R13	TR-13	30
	11	DEO076	GR13 185/195/205-13	GR13 185/195/205R13	TR-13	20
	12	DEO073	KR13 215/225/235-13	KR13 215/225/235R13	TR-13	20
	13	DEO072	7.50-13	7.50R13	TR-13	20
	14"	14	DEO032	ER14 4.00/4.50-14	ER14 4.00/4.50R14	TR-15
15		DEO006	FR14 165/175/70-14	FR14 YKR14 165/175/70R14	TR-13	30
16		DEO007	GR14 175/185-14	GR14 175/185R14	TR-13	25
17		DEO055	KR14 195/205-14	KR14 YKR14-02 195/205R14	TR-13	20
15"	18	DEO071	DR15 125-15	DR15 125R15	TR-13	40
	19	DER312	4.00/4.50-15	4.00/4.50R15	TR-15	40
	20	DEO074	ER15 135/140/145/150R15 155/70-15	ER15 135/140/145/150R15 155/70R15	TR-13	35
	21	DEO029	5.00-15	5.00R15	TR-13	35
	22	DEO023	FR15 165/175/70-15	FR15 165/175/70R15	TR-13	25
	23	DEO010	GR15 175/185/70-15	GR15 175/185/70R15	TR-13	25
15"	24	DEO009	GR15 175/185/70-15	GR15 175/185/70R15	TR-15	25
	25	DEO028	KR15 195/205-15	KR15 195/205R15	TR-13	20
	26	DEO069	MR15 215/225/235/70-15	MR15 215/225/235/70R15	TR-13	20
16"	27	DEO038	5.00/5.50-16	5.00/5.50R16	TR-15	25
	28	DEO044	5.00/5.50-16	5.00/5.50R16	TR-13	25

4x4

		KOD	ROZMIAR	ZAWÓR	IL. W KARTONIE
15"	1	DTE001	235/75 R 15	TR-13	20
	2	DTE002	225/70 R 15	TR-13	20
	3	DTE003	255/70 R 15	TR-13	15
	4	DTE004	265/70 R 15	TR-13	15
	5	DTE005	30x9.50 R 15	TR-13	15
	6	DTE006	31x10.50 R 15	TR-13	15
	7	DTE015	32x11.50 R 15	TR-13	12
	8	DTE018	33x12.50 R 15	TR-13	10
	9	DTE019	35x12.50 R 15	TR-13	10
16"	10	DTE007	235/85 R 16	TR-13	18
	11	DTE008	225/75 R 16	TR-13	18
	12	DTE009	245/75 R 16	TR-13	15
	13	DTE010	265/75 R 16	TR-13	15
	14	DTE011	235/70 R 16	TR-13	18
	15	DTE012	245/70 R 16	TR-13	15
	16	DTE013	255/70 R 16	TR-13	15
	17	DTE014	265/70 R 16	TR-13	15
	18	DTE016	285/75 R 16	TR-13	12
	19	DTE017	295/75 R 16	TR-13	12
	20	DTE020	315/75 R 16	TR-13	10

DO SAMOCHODÓW DOSTAWCZYCH

		KOD	ROZMIAR	DODATKOWY OPIS	ZAWÓR	IL. W KARTONIE
12"	1	DEC278	145/155-12	145/155R12	V3.02.5	30
13"	2	DEC279	165/70-13	165/70R13	V3.02.5	35
	3	DEC280	165/175/70-14	165/175/70R14	V3.02.7	30
14"	4	DEC282	5.90-14	5.90R14	V3.02.18	30
	5	DEC281	195/205-14	195/205R14	V3.02.7	20

DO SAMOCHODÓW DOSTAWCZYCH

		KOD	ROZMIAR	DODATKOWY OPIS	ZAWÓR	IL. W KARTONIE
15"	6	DEC230	6.00-15	6.00R15	V3.02.7	25
	7	DEO059	JR 78-15		TR-15	20
	8	DEC187	MR 15 215/225/235/70-15	MR 15 215/225/235/70R15	V3.02.18	18
16"	9	DEO011	6.00/6.50-16	6.00/6.50R16	TR-15	20
	10	DEO036	6.00/6.50-16	6.00/6.50R16	TR-13	20
	11	DEO030	6.00/6.50-16	6.00/6.50R16	V3.02.18	20
	12	DEO033	6.00/6.50-16	6.00/6.50R16	TR-75A	20
	13	DEC079	7.50/8.25-16	7.50/8.25R16	V3.02.8	12
	14	DEO034	175/185-16	GR16 YKR16-01 175/185R16	TR-13	25
	15	DEO016	195/205/215/70-16	KR16 195/205/215/70R16	TR-13	20
	16	DEO065	195/205/215/70-16	KR16 195/205/215/70R16	TR-15	20
	17	DER167	7.00/7.50-16	7.00/7.50R16	TR-13	18
	18	DEO058	225/235/245/255/70-16	MR16 225/235/245/255/70R16	TR-13	18

DO MASZYN ROLNICZYCH I LEŚNYCH

		KOD	ROZMIAR	DODATKOWY OPIS	ZAWÓR	IL. W KARTONIE
12"	1	DEO047	5.00-12	5.00 R12	TR-218A	30
	2	DEO060	6.00-12	6.00 R12	TR-15	40
	3	DER283	10.0/80-12	10.0/80 R12	TR-13	15
	4	DET103	10.0/80-12	10.0/80 R12	V3.02.7	15
	5	DER146	10.0/80-12	10.0/80 R12	JS-2	15
	6	DER118	10.0/80-12	10.0/80 R12	TR-15	15
14.5"	7	DER360	200/60-14.5		TR-13	25
	8	DER364	200/60-14.5		TR-15	25
	9	DER263	30x11.5/14.5		V3.02.8	12
	10	DER180	30x11.5/14.5		V3.02.2	12
15"	11	DER132	5.00-15	5.00 R15	TR-15	35
	12	DER213	6.00-15	6.00 R15	TR-218A	25
	13	DEO027	6.70/7.50-15	6.70/7.50 R15	TR-15	20
	14	DEO041	7.5L-15		TR-15	20
	15	DER261	7.5L-15		TR-218A	20
	16	DER480	7.5/9.5LR14/15		TR-13	20
	17	DER140	12.5/60-15		TR-15	12
	18	DER497	11L15		TR-15	12
15.3"	19	DER010	400/60-15.5		TR-15	10
	20	DER005	10.0/75-15.3		TR-15	15
	21	DER006	10.0/75-15.3		TR-218A	15
	22	DER007	11.5/80-15.3		TR-15	12
	23	DER211	11.5/80-15.3		TR-218A	12
	24	DER539	12.5L 15/16		TR-15	12
	25	DER009	12.5/80-15.3		TR-15	10
15.5"	26	DER181	400/60-350/70-15.5		TR-15	10
	27	DER200	400/60-350/70-15.5		TR-218A	10
	28	DEC427	400/60-350/70-15.5		TR-150	10
	29	DER182	500/55-15.5		TR-15	10
16"	30	DER046	4.00/4.50-16	4.00/4.50 R16	TR-15	40
	31	DER001	6.00-16	6.00 R16	TR-15	25
	32	DER325	6.00-16	6.00 R16	TR-218A	25
	33	DER326	6.50-16	6.50 R16	TR-218A	20
	34	DER496	7.00-16	7.00 R16	TR-15	18
	35	DER002	7.50-16	7.50 R16	TR-15	18
	36	DEC474	7.50-16	7.50 R16	TR-150	18
	37	DER199	7.50-16	7.50 R16	TR-218A	18
	38	DER256	8.25-16	8.25 R16	TR-218A	12
	39	DER003	9.00/10.00-16	9.00/10.00 R16	TR-15	12
	40	DER272	9.00/10.00-16	9.00/10.00 R16	TR-218A	12
	41	DER251	10.5-16	10.5 R16	TR-218A	15
	42	DER045	10.5/65-16	10.5/65 R16	TR-15	15
	43	DER144	11.00-16	11.00 R16	TR-15	10
	44	DER145	11.00-16	11.00 R16	TR-218A	10
	45	DER124	12.0/65/75-16	12.0/65/75 R16	TR-15	10
	46	DER008	14.0/65-16	14.0/65 R16	TR-15	10
	16.1"	47	DER687	14L16.1		TR-15
16.5"	48	DER253	10-16.5	10 R16.5	TR-15	15
	49	DER248	12-16.5	12 R16.5	TR-15	12

DO MASZYN ROLNICZYCH I LEŚNYCH

		KOD	ROZMIAR	DODATKOWY OPIS	ZAWÓR	IL. W KARTONIE
17"	49	DER087	15.0/55-17	380/55-17 15.0/55 R17	TR-15	7
	50	DER292	15.0/55-17	380/55-17 15.0/55 R17	TR-218A	7
	51	DER089	19.0/45-17	500/50-17 500/50 R17 19.0/45 R17	TR-15	5
	52	DER202	19.0/45-17	500/50-17 500/50 R17 19.0/45 R17	TR-218A	5
17.5"	53	DER270	215/75-17,5	215/75 R17,5	TR-15	15
	54	DER481	14-17,5	14 R17,5	TR-15	8
	55	DER482	14-17,5	14 R17,5	TR-218A	8
18"	56	DER335	4.50/4.75/5.00-18	4.50/4.75/5.00 R18	TR-13	40
	57	DER038	6.00-18	6.00 R18	TR-15	15
	58	DER226	6.00-18	6.00 R18	TR-87	15
	59	DER229	7.50-18	7.50 R18	TR-15	15
	60	DER225	7.50-18	7.50 R18	TR-218A	15
	61	DER275	7.50-18	7.50 R18	V3.04.10	15
	62	DER128	10.0/80-18	10.5/80 R18	TR-15	9
	63	DER136	10.0/80-18	10.5/80 R18	TR-218A	9
	64	DER020	12.5/80-18	12.5/80 R18	TR-15	9
	65	DER021	12.5/80-18	12.5/80 R18	TR-218A	9
	66	DER103	13.0/65-18	13.0/65 R18	TR-15	9
	67	DER081	13.0/75-18	13.0/75 R18	TR-218A	9
	68	DER350	14.5/80-18	14.5/80 R18	TR-218A	8
	69	DER149	15.0/70-18	15.0/70 R18	TR-15	8
70	DEC156	15.0/70-18	15.0/70 R18	V3.04.23	6	
71	DEC178	16.5/70-18	16.5/70 R18	TR-15	6	
19"	72	DER311	4.00/4.50/4.75/5.00-19	4.00/4.50/4.75/5.00 R19	TR-13	20
	73	DER327	4.00/4.50/4.75/5.00-19	4.00/4.50/4.75/5.00 R19	TR-15	20
	74	DER304	6.00-19	6.00 R19	TR-15	15
	75	DER478	8.00-19	8.00 R19	TR-13	15
19.5"	76	DER212	18-19,5	18 R19,5	TR-15	6
	77	DER280	18-19,5	18 R19,5	TR-218A	6
	78	DER298	18-19,5	18 R19,5	TR-300	6
20"	79	DER141	6.50-20	6.50 R20	SP-5	15
	80	DER019	7.00/7.50-20	7.00/7.50 R20	SP-5	15
	81	DER054	6.50-20	6.50 R20	TR-13	15
	82	DER044	6.50-20	6.50 R20	TR-15	15
	83	DER004	7.00/7.50-20	7.00/7.50 R20	TR-15	15
	84	DER308	8.00/9.5-20	9.5/9-20 8.00/9.5 R20	TR-15	12
	85	DER086	8.00/9.5-20	9.5/9-20 8.00/9.5 R20	TR-218A	12
	86	DEC479	10.00-20	10.00 R20	TR15	10
	87	DER092	11.2-20	11.2/10-20 11.2R20 (280/85R20)	TR-218A	7
	88	DER121	10.5/80-20	10.5 R20	TR-15	12
	89	DER110	10.5/80-20	10.5 R20	TR-218A	12
	90	DER344	10.5/80-20	10.5 R20	V3.06.8	12
	91	DER036	12.5/80-20	12.5 R20	TR-15	7
	92	DER053	12.5/80-20	12.5 R20	TR-218A	7
	93	DER247	14.5/80-20	14.5 R20	TR-15	7
	94	DER090	14.5/80-20	14.5 R20	TR-218A	7
	95	DER172	14.5/80-20	14.5 R20	V3.02.18	6
	96	DER133	14.5/80-20	14.5 R20	TRJ-650	6
97	DER066	16/70-20	405/70-20	V 3.06.8	6	
98	DER230	16/70-20	405/70-20	V 3.04.5	6	
99	DER071	16/70-20	405/70-20	TR-218A	6	
100	DER070	16/70-20	405/70-20	TR-15	6	
101	DER361	20.0/70-20	20.0/70 R20	TR-15	5	
102	DER405	260/70-280/70-20	260/70-280/70 R20	TR-218A	12	
22"	103	DER363	8.3/9.5-22	260/70-22	TR-15	10
22.5"	104	DER372	8.3/9.5-22.5	8.3/9.5 R22.5	TR-15	10
	105	DER316	10.00-R22.5	10.00 RR22.5	TR-300	10
	106	DER317	11.00-R22.5	11.00 RR22.5	TR-300	8
	107	DER318	12.00-R22.5	12.00 RR22.5	TR-300	8
	108	DER286	13-22.5	13 R22.5	TR-300	6
	109	DER314	15-22.5	385/65-22.5	TR-300	5
	110	DER331	16.5/18-22.5	16.5R22.5 18R22.5	TR-300	5
	111	DEC215	16.5/18-22.5	16.5R22.5 18R22.5	TR-218A	5
	112	DER341	18-22.5	445/65-22.5	TR-15	5
	24"	113	DER050	8.3/9.5-24	8.3/8-24 9.5/9-24 8.3R24 9.5R24 (260/70R24 300/70R24 250/85R24)	TR-218A
114		DER011	11.2/12.4-24	11.2/10-24 12.4/11-24 11.2R24 12.4R24 (320-360/70R24 280-320/85R24)	TR-218A	7
115		DER373	13.00-24	13.00 R24	TR-218A	7
116		DER375	13.00-24	13.00 R24	TR - 220	7
117		DER022	14.00-24	14.00 R24	TR-218A	6

		KOD	ROZMIAR	DODATKOWY OPIS	ZAWÓR	IL. W KARTONIE
24"	118	DER300	14.00-24	14.00 R24	TR - 220	6
	119	DER374	13.6-24 (narrow)	13.6/12-24 13.6R24 (340/85R24)	TR-218A	7
	120	DER012	13.6/14.9-24	13.6/12-24 14.9/13-24 13.6R24 14.9R24 (360-380-420/70R24 340-380/85R24)	TR-218A	6
	121	DER027	14.9-24	14.9/13-24 14.9R24 (420/70R24 380/85R24)	TR-218A	6
	122	DER277	15.5/80-24; 16.5/85-24	400/80-24	TR-218A	6
	123	DER336	16.0/70-24	16.0/70 R24	TR-218A	6
	124	DER104	16.9-24	16.9/14-24 16.9R24 (420/85R24)	TR-218A	4
	125	DER197	17.5-24	17.5LR24 (445/70R24 460/70R24)	TR-218A	4
	126	DER527	18.4-24	17.5LR24 (445/70R24 460/70R24)	TR-218A	4
	127	DER414	19.5L24	19.5LR24 (500/70R24)	TR-218A	4
	128	DER198	420-460/70-24	420-460/70R24	TR-218A	4
	129	DER495	21.3-24	21.3R24	TR-218A	2
26"	130	DER313	13.6/14.9-26	13.6/12-26 14.9/13-26 14.9R26 (380-420/70R26 380/85R26)	TR-218A	5
	131	DER100	16.9/18.4-26	16.9/14-26 18.4/15-26 16.9R26 18.4R26 (480-540/70R26 480/80R26 460/85R26)	TR-218A	3
	132	DER060	23.1-26	23.1/18-26 23.1R26 (620/75R26)	TR-218A	2
	133	DER617	28.1-26 NEW	28.1LR26 NEW	TR-218A	1
	134	DER388	28.1-26 large	28.1LR26 large	TR-218A	1
26.5"	135	DER246	600/55-26.5	600/55 R26.5	TR-218A	2
	136	DER163	700/50-26.5	700/50 R26.5	TR-218A	2
	137	DER420	8.3/9.5-28	8.3/8-28 9.5/9-28 9.5R28	TR-218A	8
28"	138	DER330	9.5-28	9.5/10R28	TR-218A	6
	139	DER013	11.2/12.4-28	11.2/10-28 12.4/11-28 11.2R28 12.4R28 (320-360/70R28 280-320/85R28)	TR-218A	6
	140	DER026	13.6-28	13.6/12-28 13.6R28 (380/70R28 340/85R28)	TR-218A	5
	141	DER014	13.6/14.9-28	13.6/12-28 14.9/13-28 13.6R28 14.9R28 (380-420/70R28 340-380/85R28)	TR-218A	5
	142	DER048	16.9-28	16.9/14-28 16.9R28 (480/70R28 420/85R28)	TR-218A	4
	143	DER390	18.4-28	18.4/15-28 18.4R28	TR-218A	3
	144	DER217	4.00-30	4.00 R30	TR-15	20
30"	145	DER303	14.9/15.5-30	(380/85R30)	TR-218A	4
	146	DER030	16.9-30	16.9/14-30 16.9R30 (480/70R30 420/85R30)	TR-218A	4
	147	DER031	18.4-30	18.4/15-30 18.4R30 (520/70R30 460/85R30)	TR-218A	3
	148	DER309	21LR30, 23.1R30	23.1-30	TR-218A	2
	149	DER323	600/55/60-30.5	600/55/60-30.5	TR-218A	2
32"	150	DER095	8.3/9.5-32	8.3/8-32 9.5/9-32 8.3R32 9.5R32 (300/70-32 230/95-32)	TR-218A	8
	151	DER015	11.2/12.4-32	11.2/10-32 12.4/11-32 11.2R32 12.4R32 (360/70R32 320/85R32)	TR-218A	5
	152	DER306	24.5-32	24.5R32 (650/75R32)	TR-218A	2
	153	DER391	30.5-32	30.5LR32	TR-218A	1
34"	154	DER017	16.9/18.4-34	16.9/14-34 18.4/15-34 16.9R34 18.4R34 (540/65R34 480-520/70R34 420-460/85R34)	TR-218A	3
	155	DER387	20.8-34	20.8R34	TR-218A	3
	156	DER667	600/65-34	600/65R34	TR-218A	2
	157	DER668	700/55-34	700/55R34	TR-218A	2
	158	DER669	23.1-34	23.1R34	TR-218A	2
36"	159	DER084	4.00-36	4.00 R36	TR-15	15
	160	DER218	4.00-36	4.00 R36	TR-218A	15
	161	DER094	8.3/9.5-36	8.3/8-36 9.5/9-36 8.3R36 9.5R36 (210-230/95R36)	TR-218A	7
	162	DER278	11.2/12.4-36	11.2/10-36 12.4/12-36 11.2R36 12.4R36 (320-360/70R36)	TR-218A	5
	163	DER546	13.6-36	13.6/12-36 13.6R36 (380/70R36)	TR-218A	4
38"	164	DER594	8.3/9.5-38	8.3/8-38 9.5/9-38 8.3R38 9.5R38	TR-218A	6
	165	DER362	12.4-38	12.4/11-38 12.4R38 (360/70R38 320/85R38)	TR-218A	5
	166	DER093	13.6/14.9-38	13.6/12-38 14.9/14-38 13.6R38 14.9R38 (380-420/70R38 380/80R38 340-380/85R38)	TR-218A	4
	167	DER109	15.5-38	15.5R38 (420/70R38)	TR-218A	3
	168	DER279	16.9-38	16.9/14-38 16.9R38 (480/70R38 420/85R38)	TR-218A	3
	169	DER018	18.4-38	18.4/15-38 18.4R38 (520/70R38 460/85R38)	TR-218A	3
	170	DER047	20.8-38	20.8R38 (520/85R38)	TR-218A	2
	171	DER295	650/60-38	650/60R38	TR-218A	2
	172	DER321	710/70-38 650/85-38 narrow	710/70R38 650/85R38 narrow	TR-218A	2
	173	DER618	710/70-38 NEW	710/70R38 NEW	TR-218A	1
40"	174	DER349	8.3/9.5-40	8.3/8-40 9.5/9-40 9.5R40	TR-218A	6
	175	DER098	8.3/9.5-42	8.3/8-42 9.5/9-42 9.5R42 (230/95R42)	TR-218A	6
42"	176	DER545	11.2/10-42	11.2R42 (300/85R42)	TR-218A	5
	177	DER129	20.8-42	20.8R42 (580/70R42 520/85R42)	TR-218A	1
	178	DER672	710/70-42	710/70R42	TR-218A	1
44"	179	DER289	9.5/9-44	9.5R44 (230/95R44)	TR-218A	6
	180	DER549	11.2-44	11.2R44	TR-218A	5
46"	181	DER554	12.4/46	12.4R46 (320/90R46)	TR-218A	4
	182	DER580	13.6/14.9-46 NEW	13.6/14.9R46 NEW	TR-218A	3
	183	DER616	16.9/18.4-46 NEW	16.9/18.4R46 NEW	TR-218A	2
48"	184	DER517	9.5/9-48	9.5R48 (230/95R48)	TR-218A	6
	185	DER526	11.2/10-48	11.2R48 (270/95R48)	TR-218A	5
	186	DER555	13.6/12-48	13.6R48 (340/90R48)	TR-218A	3

DO MASZYN BUDOWLANYCH

		KOD	ROZMIAR	DODATKOWY OPIS	ZAWÓR	IL. W KARTONIE
14"	1	DEO049	26x8.00-14	26x8.00R14	V3.04.10	20
	2	DET047	27x8.50/10.50-15	27x8.50/10.50R15	TR-13	20
15"	3	DET084	27x8.50/10.50-15	27x8.50/10.50R15	TR-15	20
	4	DER315	29x12.00/12.50-15	29x12.00/12.50R15	TR-218A	15
	5	DER169	31x10.50/11.50-15	31x10.50/11.50R15	TR-13	15
	6	DER126	31x12.50/13.50-15	31x12.50/13.50R15	TR-13	12
	7	DER138	31x15.50-15	31x15.50R15	TR-13	12
	8	DER179	33x12.50/15.50-15	33x12.50/15.50R15	TR-13	12
24"	9	DEC058	14.00-24	14.00R24	TR-177A	6
	10	DER228	14.00-24	14.00R24	TRJ-1175C	6
	11	DER091	20-24	20R24	TRJ-1175C	3
	12	DER403	20-24	20R24	TRJ-650	3
	13	DER305	21.3-24	21.3R24	V3.02.15	2
	14	DER450	21.3-24	21.3R24	TR177A	2
25"	15	DER119	15.5-25	15.5R25	TRJ-1175C	5
	16	DER338	15.5-25	15.5R25	TRJ-4000	5
	17	DER130	16.00-24/25	16.00R24/25	TRJ-1175C	4
	18	DER107	17.00-25	17.00R25	TRJ-1175C	4
	19	DER108	17.50-25	17.50R25	TRJ-1175C	4
	20	DER345	17.50-25	17.50R25	TRJ-4000	4
	21	DEC466	17.50-25	17.50R25	V3.02.17	3
	22	DER102	18.00-25	18.00R25	TRJ-1175C	4
	23	DER085	20.50-25	20.50R25	TRJ-1175C	3
	24	DER337	20.50-25	20.50R25	TRJ-4000	3
	25	DEC444	20.50-25	20.50R25	V3.02.17	3
	26	DER061	23.5-25	23.5R25	TRJ-1175C	2
	27	DER351	23.5-25	23.5R25	TRJ-4000	2
	28	DER062	25.5-25	25.5R25	TRJ-1175C	2
	29	DER074	26.5-25	26.5R25	TRJ-1175C	2
	30	DEC468	26.5-25	26.5R25	V3.02.17	2
	31	DER382	29.5-25	29.5R25	TRJ-1175C	1
	32	DEC469	29.5-25	29.5R25	V3.02.17	1
33"	33	DER139	18.00-33	18.00R33	TRJ-1175C	3
	34	DER358	21.00-33	21.00R33	V3.02.17	1
	35	DER385	21.00-33	21.00R33	TRJ-1175C	1

DO WÓZKÓW TRANSPORTOWYCH I WIDŁOWYCH

		KOD	ROZMIAR	DODATKOWY OPIS	ZAWÓR	IL. W KARTONIE
2"	1	DET062	200-50		TR-87	100
3"	2	DET176	210X65/250-3		TR-87	100
4"	3	DET157	2.50/2.80-4		TR-87	100
	4	DET237	3.00-4	3.00 R4	TR-87	100
	5	DET035	3.00-4	3.00 R4	TR-13	100
	6	DET238	4.00-4	4.00 R4	TR-87	100
	7	DET034	4.00-4	4.00 R4	TR-13	100
	8	DET150	11x4.00-4	11x4.00 R4	TR-13	100
	9	DET229	11x7.00-4	11x7.00 R4	TR-87	50
	10	DET175	4.10/3.50-5	4.10/3.50 R5	TR-13	100
5"	11	DET108	4.10/3.50-5	4.10/3.50 R5	TR-87	100
	12	DET271	11X4.00-5	11X4.00 R5	TR-87	100
	13	DET148	11x6.00-5	11x6.00 R5	TR-87	50
6"	14	DET033	3.50/4.00-6	3.50/4.00 R6	TR-13	75
	15	DET022	3.50/4.00-6	3.50/4.00 R6	TR-87	75
	16	DET221	145/70-6	145/70 R6	TR-87	75
	17	DET088	13x5.00-6	13X5.00 R6	TR-13	75
	18	DET087	13x5.00-6	13X5.00 R6	TR-87	75
	19	DET036	15x6.00-6	15x6.00 R6	TR-13	50
	20	DET071	15x6.00-6	15x6.00 R6	TR-87	50
7"	21	DET198	3.50/4.00-7	3.50/4.00 R7	TR-13	75
	22	DET220	16x8-7	16x8 R7	TR-87	35
8"	23	DET064	3.00/3.25-8	3.00/3.25 R8	TR-13	75
	24	DET065	3.00/3.25-8	3.00/3.25 R8	TR-87	75
	25	DET160	3.50-8	3.50 R8	TR-87	75
	26	DET139	145/70-8	145/70 R8	TR-87	75
	27	DET003	4.00-8	4.00 R8	TR-87	75
	28	DET004	4.00-8	4.00 R8	TR-13	75
	29	DET115	4.00-8	4.00 R8	JS-2	75

		KOD	ROZMIAR	DODATKOWY OPIS	ZAWÓR	IL. W KARTONIE
8"	30	DET007	5.00-8	5.00 R8	TR-87	50
	31	DET016	5.00-8	5.00 R8	TR-13	50
	32	DET140	5.00-8	5.00 R8	JS-2	50
	33	DET019	16x6.5/7.5-8	16X6.5/7.5 R8	TR-13	35
	34	DET017	18x8.50/9.50-8	18x8.50/9.50 R8	TR-13	30
	35	DET023	18x8.50/9.50-8	18x8.50/9.50 R8	TR-87	30
	36	DET086	20x8.00/10.00-8	20x8.00/10.00 R8	TR-13	30
	37	DET280	22x10.00-8	22x10.00R8	GP-4	18
	38	DET040	18x7-8	18x7 R8	V3.02.5	35
	39	DET043	18x7-8	18x7 R8	TR-13	35
40	DET118	18x7-8	18x7 R8	JS-2	35	
9"	41	DET028	5.00-9	5.00 R9	TR-15	50
	42	DET008	6.00-9	6.00 R9	TR-87	40
	43	DET072	6.00-9	6.00 R9	TR-13	40
	44	DET037	6.00-9	6.00 R9	TR-15	40
	45	DET109	6.00-9	6.00 R9	JS-2	40
	46	DET279	25x12.00/13.00-9	25x12.00/13.00R9	TR-13	20
	47	DET014	3.00/3.50/4.00-10	3.00/3.50/4.00 R10	TR-13	50
	48	DET005	4.00/4.40-10	4.00/4.40 R10	TR-13	50
	49	DET006	4.00-10	4.00 R10	TR-87	50
	50	DET018	5.00-10	5.00 R10	TR-13	50
10"	51	DET127	5.00-10	5.00 R10	TR-15	50
	52	DET025	5.0/5.00-10	5.0/5.00 R10	TR-218A	50
	53	DET009	6.50-10	6.50 R10	TR-87	30
	54	DET143	6.50-10	6.50 R10	TR-13	30
	55	DET078	6.50-10	6.50 R10	JS-2	30
	56	DET144	18x8/8.50/10.50-10	18x8/8.50/10.50 R10	TR-13	30
	57	DET066	20x8.00/10.00-10	20x8.00/10.00 R10	TR-13	30
	58	DET112	21x7/8/9.00-10	21x7/8/9.00 R10	GP-4	30
	59	DET135	23x9-10	23x9 R10	JS-2	30
	60	DET203	23x9-10	23x9 R10	TR-75A	20
	61	DET050	23x9-10	23x9 R10	V3.02.7	30
11"	62	DEO075	560x165-11	560x165 R11	TR-87	40
12"	63	DET155	4.00-12	4.00 R12	TR-13	60
	64	DET015	5.00-12	5.00 R12	TR-13	35
	65	DET197	5.00-12	5.00 R12	TR87	40
	66	DEO026	6.00-12	6.00 R12	TR-218A	30
	67	DET068	6.5/80-12	6.5/80 R12	TR-218A	30
	68	DET010	7.00-12	7.00 R12	V3.02.18	20
	69	DET031	7.00-12	7.00 R12	TR-75A	20
	70	DET117	7.00-12	7.00 R12	JS-2	20
	71	DET039	7.00-12	7.00 R12	TR-13	20
	72	DET069	7.00-12	7.00 R12	TR-218A	20
	73	DET058	23x8.5/10.5-12	23x8.5/10.5 R12	TR-13	20
	74	DET119	23x8.5/10.5-12	23x8.5/10.5 R12	TR-15	20
	75	DET094	24x12.00/13.00-12	24x12.00/13.00R12	TR-13	15
	76	DET129	23x8.5/10.5-12	23x8.5/10.5 R12	TR-218A	20
	77	DET059	23x10-12	23x10 R12	TR-13	20
	78	DET110	26x12.00-12	26x12.00 R12	TR-13	15
79	DET111	26x12.00-12	26x12.00 R12	TR-15	15	
80	DET137	26x12.00-12	26x12.00 R12	TR-218A	15	
81	DET107	27x10-12	27x10 R12	V3.02.3	15	
82	DET079	27x10-12	27x10 R12	JS-2	15	
13"	83	DET138	21x4		JS-2	35
	84	DET102	23-5	5.00 R13	TR-13	25
	85	DET011	23-5	5.00 R13	GW 4B 50°x65	25
	86	DET100	23-5	5.00 R13	V3.02.19	25
15"	87	DEO022	215-15	215 R15	V3.06.18	20
	88	DET013	250-15	250 R15	V3.02.18	18
	89	DET136	250-15	250 R15	JS-2	20
	90	DET116	250/300-15	250 R15	TR-75A	20
	91	DET046	300-15	300 R15	V3.02.8	15
	92	DEC100	300-15	300 R15	V3.04.10	15
	93	DER297	28x9-15	28x9 R15	V3.02.18	20
	94	DER183	32x12.1-15	32x12.1 R15	TR-177A	12
	95	DET152	7.00-15	7.00 R15	JS-2	20
	96	DET029	7.50-15	7.50 R15	V3.02.8	18
	97	DET012	8.15-15	8.15 R15	V3.02.18	20
	98	DET141	7.50/8.15-15	7.50/8.15 R15	JS-2	20

FLOTACYJNE / LEŚNICTWO

		KOD	ROZMIAR	ZAWÓR	IL. W KARTONIE
22.5"	1	DER158	400/55-22.5	TR-218A	5
	2	DER255	445/65-22.5	TR-218A	5
	3	DER159	500/45-22.5	TR-218A	2
	4	DER550	500/60-22.5	TR-218A	2
	5	DER176	500/550/60-22.5	TR-218A	2
	6	DER175	600/50-22.5	TR-218A	2
	7	DER177	600/55-22.5	TR-218A	2
	8	DER178	650/60-22.5	TR-218A	2
	9	DER168	700/45-22.5	TR-218A	2

DO MOTOCYKLI

		KOD	ROZMIAR	DODATKOWY OPIS	ZAWÓR	IL. W KARTONIE
10"	1	DEM026	3.00/3.50-10	3.00/3.50 R10	V1.09.1	50
	2	DEM001	3.00/3.50-10	3.00/3.50 R10	TR-87	50
12"	3	DEM030	3.00/3.50-12	3.00/3.50 R12	TR-87	50
	4	DEM002	3.00-12	3.00 R12	V1.09.1	50
16"	5	DEM003	2.50/2.75/3.00-16	2.50/2.75/3.00 R16	V1.09.1	50
	6	DEM031	3.00-16 HD	3.00 R16 heavy duty	V1.09.1	25
	7	DEM004	3.50-16	3.50 R16	V1.09.1	40
	8	DEM050	3.25/3.50-16 HD	3.25/3.50 R16 heavy duty	V1.09.1	15
17"	9	DEM049	4.00-17 HD	4.00 R17 heavy duty	V1.09.1	15
	10	DEM041	4.50-17	4.50 R17	V1.09.1	30
	11	DEM042	4.50-17 HD	4.50 R17 heavy duty	V1.09.1	20
	12	DEM056	4.50-17 HD cross	4.50 R17 heavy duty (cross)	V1.09.1	15
18"	13	DEM046	3.00-18	3.00 R18	V1.09.1	40
	14	DEM045	3.00-18 HD	3.00 R18 heavy duty	V1.09.1	20
	15	DEM006	3.50-18	3.50 R18	V1.09.1	40
	16	DEM035	3.50-18 HD	3.50 R18 heavy duty	V1.09.1	20
	17	DEM051	3.50-18 HD cross	3.50 R18 heavy duty (cross)	V1.09.1	15
	18	DEM007	4.00-18	4.00 R18	V1.09.1	40
	19	DEM040	4.00-18 HD	4.00 R18 heavy duty	V1.09.1	20
	20	DEM024	4.00/4.50-18	4.00/4.50 R18	TR-13	40
	21	DEM008	4.75-18	4.75 R18	V1.09.1	40
19"	22	DEM009	2.50/2.75-19	2.50/2.75 R19	V1.09.1	40
	23	DEM009	3.00-19	3.00 R19	V1.09.1	40
	24	DEM032	3.00-19 HD	3.00 R19 heavy duty	V1.09.1	20
	25	DEM037	3.25/3.50-19 HD	3.25/3.50 R19 heavy duty	V1.09.1	20
	26	DEM010	3.50-19	3.50 R19	V1.09.1	40
	21"	27	DEM012	2.75-21	2.75 R21	V1.09.1
28		DEM034	2.75-21 HD	2.75 R21 heavy duty	V1.09.1	20
29		DEM011	3.00-21	3.00 R21	V1.09.1	40
30		DEM033	3.00-21 HD	3.00 R21 heavy duty	V1.09.1	20
31		DEM044	3.00/3.25-21 HD	3.00/3.25 R21 heavy duty	V1.09.1	20
22"	32	DEM013	2.75-22	2.75 R22	V1.09.1	40
	33	DEM038	2.75-22 HD	2.75 R22 heavy duty	V1.09.1	20
23"	34	DEM014	2.75-23	2.75 R23	V1.09.1	40
	35	DEM039	2.75-23 HD	2.75 R23 heavy duty	V1.09.1	20

DO SKUTERÓW

		KOD	ROZMIAR	DODATKOWY OPIS	ZAWÓR	IL. W KARTONIE
1		DMO001	2 1/4 -16/20x2.25	2 1/4 R16/20 x 2.25	V1.06.1	75
2		DMO002	2 1/4 -17/21x2.25	2 1/4 R17/21 x 2.25	V1.06.1	75
3		DMO003	2 3/4 -17/21x2.75	2 3/4 R17/21 x 2.75	V1.06.1	75
4		DMO004	2 1/4 -19/23x2.25	2 1/4 R19/23 x 2.25	V1.06.1	50
5		DMO005	2 1/2 -9	2 1/2 R9	TR-87	75

DĘTKI PREMIUM

WZMOCNIONA STRUKTURA ŚCIANY DĘTKI

Wzmocniona struktura ścianki dętki oznacza, że im ścianka grubsza, tym większy opór stawia gazom próbującym wydostać się na zewnątrz. Co ważne, dętka pogrubiona przeznaczona jest do pracy w trudniejszych warunkach, dzięki czemu będzie dłużej utrzymywała pożądane ciśnienie.

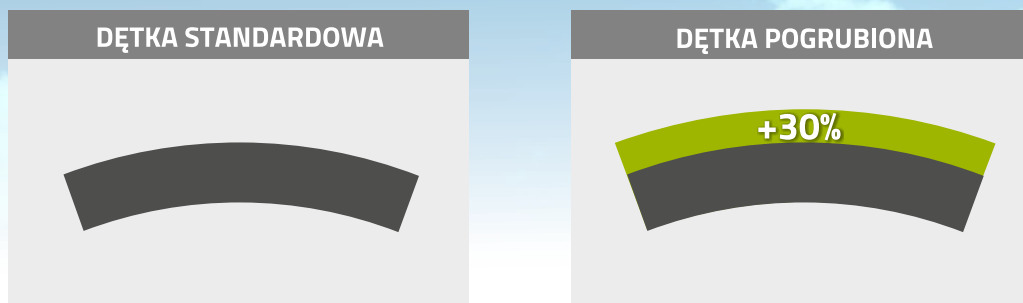

PRACA W CIĘŻKICH WARUNKACH (HEAVY DUTY), AMPLITUDY TEMPERATUR

Dętki marki Kabat mają wysoką wytrzymałość mechaniczną, wynika to z faktu, że są wykonane z kauczuku naturalnego. Zatem idealnie sprawują się w bardzo niskich temperaturach, ponieważ dętki z kauczuku naturalnego są odporne na temperatury panujące, przykładowo w rejonach Skandynawii, Syberii lub północnej Kanadzie. Co ważne, domieszka kauczuku syntetycznego uodparnia dętki na wysokie temperatury, co pozwala na stosowanie dętek Kabat Tyre przez naszych Klientów od podzwrotnikowych regionów Ameryki Południowej, przez saharyjską Afrykę Północną aż po pustynny Półwysep Arabski.



WYTRZYMAŁOŚĆ MECHANICZNA

Według badań zastosowanie grubszej struktury ścianki dętki znacząco zwiększa odporność dętki na uszkodzenia mechaniczne. Zwiększając grubość ścianki o 30% w stosunku do dętki standardowej, musimy użyć około 38% większej siły, aby móc taką strukturę rozerwać. W związku z tym dętka pogrubiona stawia o 38% większy opór dla uszkodzeń mechanicznych.

KOMFORT PRACY I TRWAŁOŚĆ

Dętki o standardowej grubości dają wspaniałe wyniki w codziennym zastosowaniu i typowym środowisku pracy. W warunkach, gdzie liczy się szczególnie odporność produktu na uszkodzenia i czynniki zewnętrzne, większa wytrzymałość ogumienia jest niezastąpiona, wtedy idealnie sprawdza się dętka PREMIUM. Co ważne, dłuższy czas życia produktu przynosi ze sobą wymierne korzyści finansowe.

	KOD	ROZMIAR	ZAWÓR	IL. W KARTONIE
1	DER619	6.00-16 Premium	TR-15	20
2	DER629	16.9-28 Premium	TR-218A	4
3	DER628	23.1-26 Premium	TR-218A	1
4	DEC683	8.25-20 Premium	V3.02.10	10
5	DER627	7.50-16 Premium	TR-15	12
6	DER626	400/60-15.5 Premium	TR-15	6
7	DER625	16.9/14-34 Premium	TR-218A	2
8	DER624	12.5/80-18 Premium	TR-218A	8
9	DER642	11.2/12.4-24 Premium	TR-218A	6
10	DER640	13.6/14.9-24 Premium	TR-218A	5
11	DER623	11.2/12.4-28 Premium	TR-218A	5
12	DER620	13.6/14.9-28 Premium	TR-218A	4
13	DER641	18.4-28 Premium	TR-218A	3
14	DEC682	10.00-20 Premium	V3.02.14	8
15	DET282	23.5-25 Premium	TRJ 1175C	1
16	DER622	11.5/80-15.3 Premium	TR-15	10
17	DER621	10.0/75-15.3 Premium	TR-15	12
18	DER631	16.9/18.4-30 Premium	TR-218A	2
19	DER630	16.9/18.4-26 Premium	TR-218A	3
20	DER639	20.8-38 Premium	TR-218A	2

OCHRANIACZE

	KOD	ROZMIAR	ZAWÓR	IL. W KARTONIE
1	OCH033	23-5	95±5 mm	30
2	OCH029	5.00-8 (A-8)	75±3 mm	80
3	OCH031	18x7-8	100±3 mm	70
4	OCH039	6.00-9 (B-9)	100±3 mm	40
5	OCH032	6.50-10 (C-10)	130±5 mm	40
6	OCH034	7.00-12 (C-12)	120±5 mm	35
7	OCH052	5.90/7.00-14	160±10 mm	10
8	OCH030	170-14,5	180±10 mm	10
9	OCH050	210-14,5	210±10 mm	10
10	OCH040	7.50/8.15-15 (C-15)	160±5 mm	20
11	OCH016	8.25-15 (E-15)	180±10 mm	10
12	OCH045	10.0/11.5-15,3 (D-15)	215±10 mm	10
13	OCH051	E-16 6.50/7.50/8.25-16 (E-16)	170±10 mm	10
14	OCH074	13.00-16	330±10 mm	10
15	OCH024	22-16	420±10 mm	2
16	OCH054	12.00/13.00-18 (F-18)	260±10 mm	10
17	OCH086	16.5/18	345±10 mm	5
18	OCH008	6.50/7.50-20 (C-20)	135±10 mm	15
19	OCH009	8.25/9.00-20 (E-20)	180±10 mm	10
20	OCH053	10.00/11.00-20 F-20 NARROW	200±10 mm	10
21	OCH010	10.00/11.00-20 (F-20) STANDARD	220±10 mm	10
22	OCH020	12.00/13.00-20 (G-20)	250±10 mm	5
23	OCH025	14.00-20 (H-20)	300±10 mm	5
24	OCH028	16.00-20, 16/70-20 (I-20)	340±10 mm	4
25	OCH047	11.00/12.00-24	220±10 mm	6
26	OCH048	13.00/14.00-24	260±10 mm	5
27	OCH068	15.5/17.5/18-25	380±10 mm	3
28	OCH061	20.5-25	470±10 mm	2
29	OCH049	23.5-25 (F-25)	495±10 mm	2
30	OCH072	26.5-25	600±10 mm	1
31	OCH069	29.5-25	645±10 mm	1

O-RINGI

	KOD	ROZMIAR	IL. W KARTONIE
1	AKC021	Tyran Ring 20 "	50
2	PGK437/OR6/24	Oring 24"x6,6	200
3	PGK263/OR6/25	Oring 25"x6,6	200
4	PGK247/OR10/25	Oring 25"x10	100
5	PGK248/OR10/29	Oring 29"x10	100
6	PGK249/OR10/33	Oring 33"x10	100
7	PGK250/OR10/35	Oring 35"x10	50
8	PGK251/OR10/39	Oring 39"x10	50
9	PGK252/OR10/45	Oring 45"x10	50
10	PGK253/OR10/49	Oring 49"x10	50
11	PGK346/OR13/51	Oring 51"x13	25
12	PGK347/OR13/57	Oring 57"x13	25

825.900-20
 DAT 1 2014
 KABAT
 MADE IN POLAND
 F 710

DYWANIKI

KOMPLET SKOSY

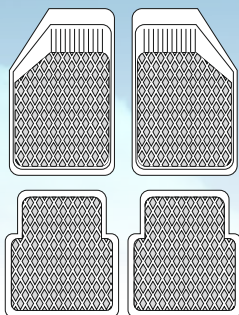

AUDI A3 AUDI A4 BMW 1 BMW 3 BMW 5 CITROEN C2 CITROEN C3 CITROEN C4 CITROEN SAXO DAEWOO MATIZ DAEWOO TICO FIAT CINQUECENTO FIAT PANDA FIAT PUNTO FIAT SEICENTO FORD FIESTA	FORD FOCUS NISSAN ALMERA OPEL CORSA OPEL MERIVA OPEL OMEGA OPEL TIGRA OPEL VECTRA OPEL ZAFIRA PEUGEOT 106 PEUGEOT 206 PEUGEOT 306 PEUGEOT 307 PEUGEOT 308 RENAULT CLIO RENAULT LAGUNA RENAULT MASTER	RENAULT MEGANE ROVER 200 ROVER 45 SEAT ALHAMBRA SEAT CORDOBA SEAT IBIZA SEAT LEON SEAT TOLEDO SKODA FABIA TOYOTA AVENSIS TOYOTA COROLLA VOLKSWAGEN BORA VOLKSWAGEN GOLF VOLKSWAGEN JETTA VOLKSWAGEN PASSAT VOLKSWAGEN POLO
--	---	---

MATIZ TYŁ

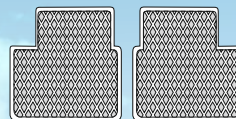

CITROEN BERLINGO
CITROEN SAXO
DAEWOO ESPERO
DAEWOO MATIZ
DAEWOO NEXIA
FIAT PUNTO
FORD FIESTA
FORD ESCORT
HYUNDAI ACCENT
MAZDA 121
NISSAN MICRA
OPEL ASTRA
OPEL CORSA
OPEL VECTRA
OPEL ZAFIRA
SUZUKI SWIFT
TOYOTA YARIS

KOMPLET JĘZYKI

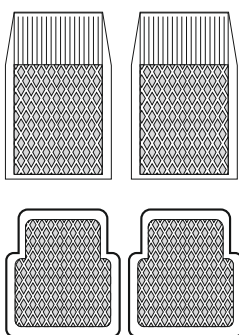

AUDI A3
AUDI A4
CITROEN SAXO
DAEWOO MATIZ
DAEWOO TICO
FIAT PUNTO
FORD FIESTA
OPEL CORSA
OPEL VECTRA
PEUGEOT 106
PEUGEOT 206
PEUGEOT 406
SEAT TOLEDO
VOLKSWAGEN GOLF
VOLKSWAGEN PASSAT

SKOS PRZÓD

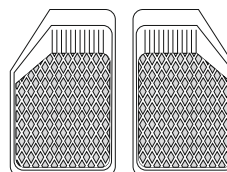

CITROEN BERLINGO
OPEL ASTRA
RENAULT KANGOO
RENAULT SCENIC
TOYOTA YARIS

PRZÓD JĘZYK

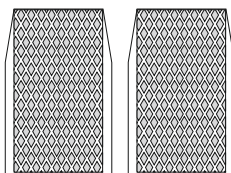

AUDI A6 CITROEN XANTIA DAEWOO LANOS DAEWOO NEXIA DAEWOO NUBIRA FIAT BRAVA FIAT BRAVO FORD MONDEO HONDA CIVIC	HYUNDAI ACCENT MAZDA 121 MAZDA 323 NISSAN MICRA NISSAN PRIMERA POLONEZ SKODA OCTAVIA SUZUKI SWIFT
--	--

TYŁ JĘZYK

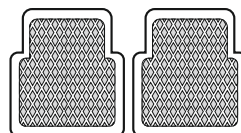

BMW 1 BMW 3 BMW 5 CITROEN C2 CITROEN C3 CITROEN C4 FIAT CINQUECENTO FIAT PANDA FIAT SEICENTO FORD FOCUS NISSAN ALMERA OPEL MERIVA OPEL OMEGA OPEL TIGRA OPEL ZAFIRA PEUGEOT 306 PEUGEOT 307	PEUGEOT 308 RENAULT CLIO RENAULT LAGUNA RENAULT MASTER RENAULT MEGANE ROVER 200 ROVER 45 SEAT ALHAMBRA SEAT CORDOBA SEAT IBIZA SEAT LEON SKODA FABIA TOYOTA AVENSIS TOYOTA COROLLA VOLKSWAGEN BORA VOLKSWAGEN JETTA VOLKSWAGEN POLO
---	---

TYŁ JĘZYK SZEROKI

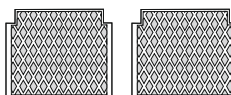

AUDI 80
AUDI 100
AUDI A6
ŁADA 2105
ŁADA 2107
VOLKSWAGEN PASSAT B3

MATY

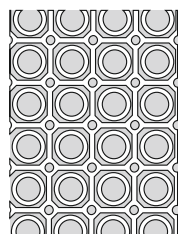

W1, W2

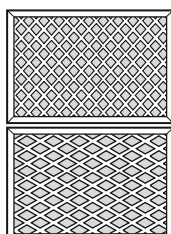

W3

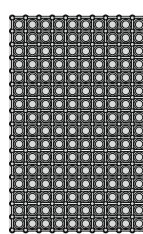

MATA
WARSZTATOWA
-
MATA
OBOROWA

785 x 590 x 17 mm
1000 x 1500 x 22,5 mm
lub cięte na wymiar

500 x 380 mm

585 x 390 x 17 mm

1200 x 1850 x 25 mm

ZAWORY

TR-13

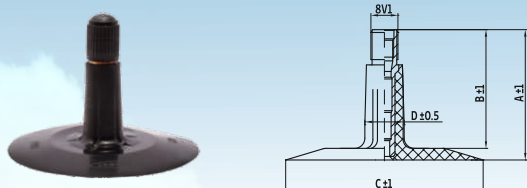

NAZWA	A (mm)	B (mm)	C (średnica mm)	D (średnica mm)
TR-13	37	33.5	56	11.2

TR-15



NAZWA	A (mm)	B (mm)	C (średnica mm)	D (średnica mm)
TR-15	37	33.5	56	16.2

TR-150

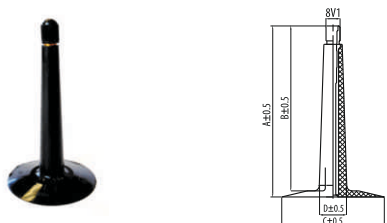

NAZWA	A (mm)	B (mm)	C (średnica mm)	D (średnica mm)
TR-150	93	89.7	56	15

TR-218

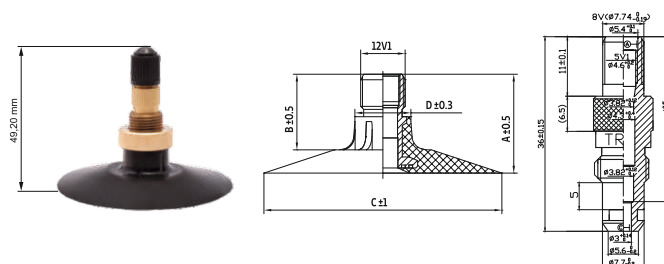

NAZWA	A (mm)	B (mm)	C (średnica mm)	D (średnica mm)
TR-218A	27	20.65	64	15.9

TR-220

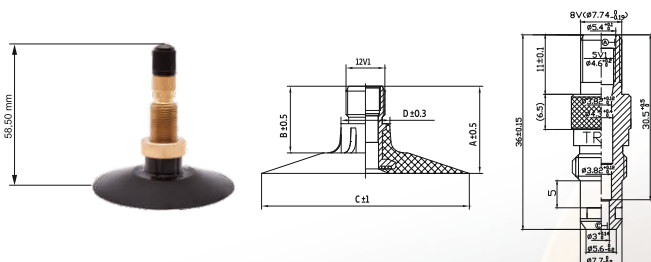

NAZWA	A (mm)	B (mm)	C (średnica mm)	D (średnica mm)
TR-220A	36	29.65	64	15.9

TR-300

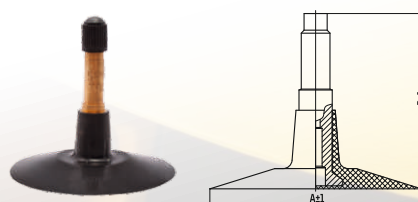

NAZWA	A (mm)	B (mm)
TR-300	70	58

TRJ1175C

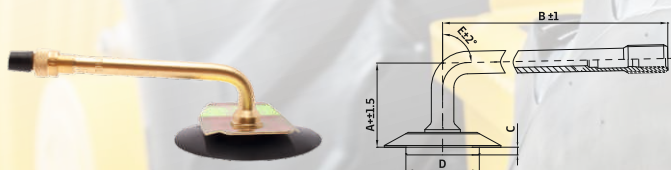

NAZWA	A (mm)	B (mm)	C (średnica mm)	D (średnica mm)	E°
TRJ1175C	35	105	4	32	88

TRJ4000-6

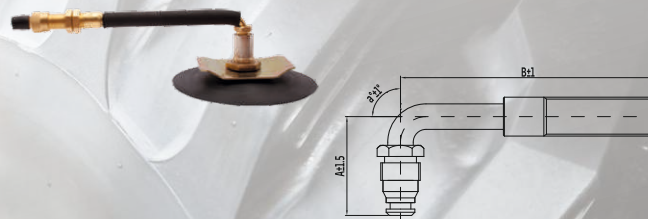

NAZWA	A (mm)	B (mm)	a°
TRJ4000-6	31	139.7	90

ZAWORY

ZAWORY

VS3-21-1

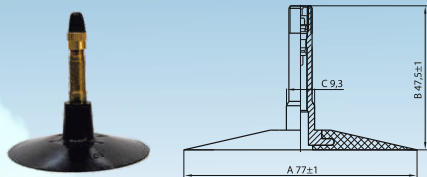

NAZWA	A (mm)	B (mm)	C (średnica mm)
VS3-21-1	77	47.5	9.3

TR75A*

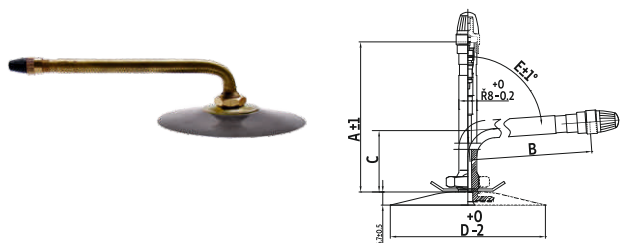

NAZWA	A (mm)	B (mm)	C (mm)	D (średnica mm)	E°
TR75A	95	76	24	82	86
TR77A	124	105	24	82	86
TR78A	146	127	24	82	86
TR177A	114	95	24	82	86
TR179A	160	141	24	82	86

PK-5A-145

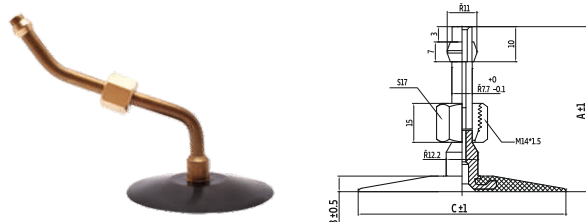

NAZWA	A (mm)	B (mm)	C (średnica mm)
PK-5A-145	145	6.7	76

V590

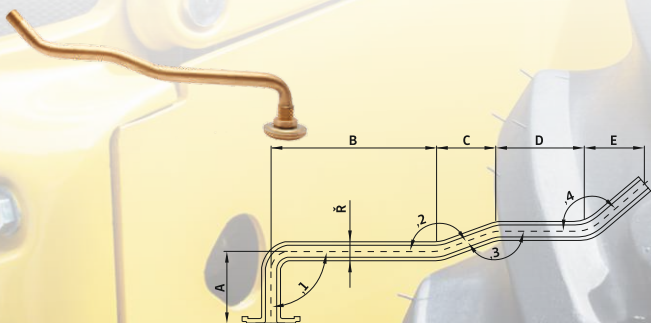

NAZWA	A(mm)	B(mm)	C(mm)	D(mm)	E(mm)	Ø(mm)	1	2	3	4
V590	38.5	90	30	50	30	10.2	90°	160°	160°	140°

V3.02...



NAZWA	A (mm)	B (mm)	a°
V3.02.1	25.5	41.5	120°
V3.02.2	22.5	43	120°
V3.02.3	33	44.5	95°
V3.02.4	39.5	44.5	110°
V3.02.5	20.5	47.5	90°
V3.02.6	23.5	60.5	110°
V3.02.7	22.5	71.5	100°
V3.02.8	20.5	89.5	94°
V3.02.9	20.5	99.5	94°
V3.02.10	20.5	115	94°
V3.02.11	20	126	98°
V3.02.12	20.5	132	94°
V3.02.13	20.5	133.5	90°
V3.02.14	20.5	138.5	94°
V3.02.15	20.5	145.5	94°
V3.02.16	20.5	149.5	90°
V3.02.17	20.5	156.5	90°
V3.02.18	22.5	74.5	90°
V3.02.19	20.5	60	94°
V3.02.20	22.5	56.5	95°
V3.02.21	20.5	172	90°
V3.02.23	29.5	66.5	90°
V3.02.24	20.5	117	90°
V3.02.26	20.5	105	94°
V3.02.27	20	75	94°
V3.02.29	20	127	94°

V3.04...

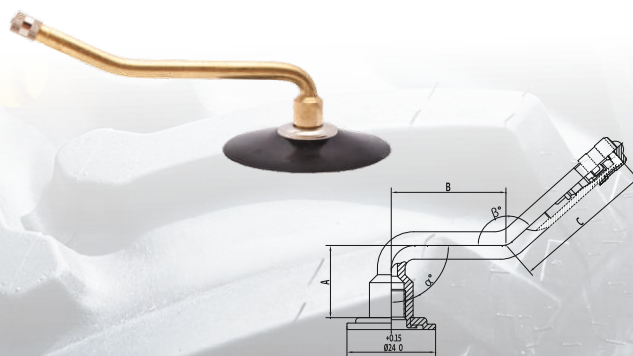

NAZWA	A (mm)	B (mm)	C (mm)	a°	β°
V3.04.1	20.5	32	37	90°	138°
V3.04.2	20.5	38	41.5	90°	153°
V3.04.3	20	59	38.5	94°	163°
V3.04.4	20	74	40	94°	144°
V3.04.5	20	76	47.5	90°	153°

ZAWORY

V3.04...

NAZWA	A (mm)	B (mm)	C (mm)	α°	β°
V3.04.6	20	86	47.5	90°	153°
V3.04.7	20.5	30.5	38	90°	154°
V3.04.8	20.5	36.5	43	90°	167°
V3.04.10	20.5	47	53	90°	154°
V3.04.11	20.5	47	63.5	90°	154°
V3.04.12	20.5	60.5	60.5	90°	159°
V3.04.14	20.5	83.5	65	90°	159°
V3.04.15	20.5	42	38.5	90°	120°
V3.04.17	20	65	45	90°	160°
V3.04.18	20	72	45	90°	160°
V3.04.20	20	68	47	94°	164°
V3.04.21	20	83	57	94°	154°
V3.04.22	20	28	47	94°	164°
V3.04.23	20	48	47	94°	164°
V3.04.24	20	58	47	94°	164°
V3.04.25	20	80	47	94°	164°
V3.04.26	20	99	42	99°	189°

V3.06...

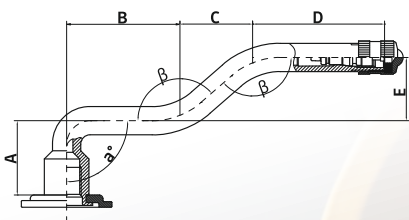

NAZWA	A (mm)	B (mm)	C (mm)	D (mm)	E (mm)	α°	β°
V3.06.1	20.5	30.5	19.5	35.5	17	90°	139°
V3.06.2	20.5	44.5	12	37.5	17	90°	125°
V3.06.3	20.5	46	20.5	47.5	17	90°	139°
V3.06.4	32.5	46.5	20.5	46.5	17	95°	140°
V3.06.5	20.5	62.5	19.5	49	17	90°	139°
V3.06.6	20	79.5	19.5	37.5	17	90°	139°
V3.06.7	20.5	45.5	18.5	42.5	17	90°	137°
V3.06.8	24.5	61.5	14.5	50.5	7.5	94°	153°
V3.06.9	20.5	67.5	19.5	54.5	17	90°	139°
V3.06.12	23.5	71.5	19.5	25.5	11.5	90°	150°
V3.06.13	20	40	13	40	7	94°	153°
V3.06.14	20	50	13	40	7	94°	153°
V3.06.15	20	60	13	40	7	94°	153°
V3.06.16	20	62	13	50	7	94°	153°
V3.06.17	20	75	13	50	7	94°	153°
V3.06.18	20	82	30	35	10	94°	153°

V3.08...

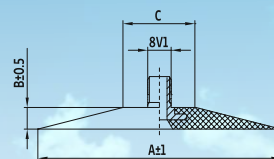

NAZWA	A (mm)	B (mm)	C (średnica mm)
V3.08.1	65	7	26
V3.08.2	70	7	26
V3.08.3	80	8	26
V3.08.4	57	5	26

SP-5 (TR-11) (V521)

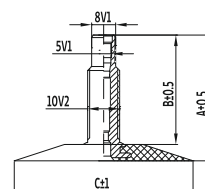

NAZWA	A (mm)	B (mm)	C (średnica mm)
SP-5	40	34.8	57

GP-4 (TR-4) (V1.09.1)

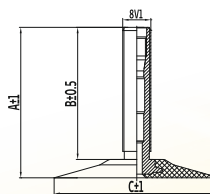

NAZWA	A (mm)	B (mm)	C (średnica mm)
GP-4	34.5	29.5	45

GP-3 (TR4A) (V1.06.1)

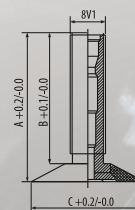

NAZWA	A (mm)	B (mm)	C (średnica mm)
GP-3	34	29.5	25

TR87

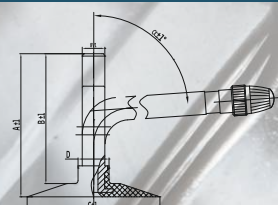

NAZWA	A (mm)	B (mm)	C (średnica mm)	D (średnica mm)	α°
TR87	48	43.5	45	10.5	90°

ZAWORY

ZAWORY

TR87A

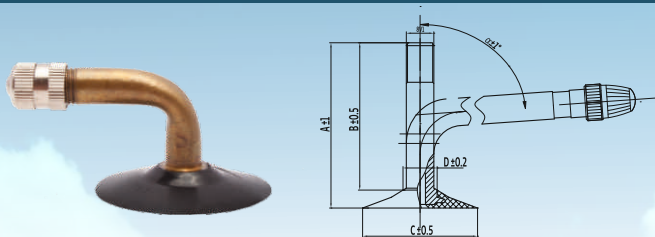

NAZWA	A (mm)	B (mm)	C (średnica mm)	D (średnica mm)	a°
TR87A	46	41	32	9.5	90

JS2

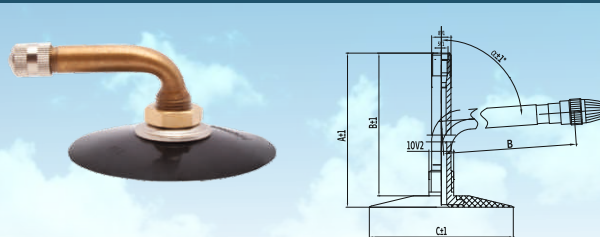

NAZWA	A (mm)	B (mm)	C (średnica mm)	a°
JS2	61	56.5	57	90

GW 4B 50°x60

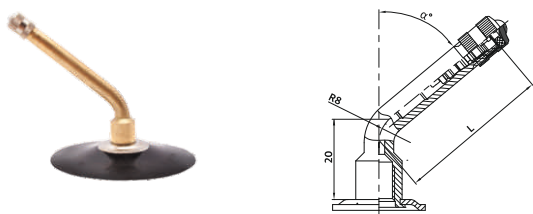

NAZWA	L	a°
GW 4B 50°x60	60	50°

Na zamówienie klienta dętki mogą być wyposażone w dowolny z oferowanych przez naszą firmę zaworów.

Powyższe zdjęcia zaworów są tylko przykładowe i rzeczywiste zawory mogą nieznacznie się od nich różnić. Niemniej jednak wszystkie zawory produkowane są według umieszczonej wyżej specyfikacji.

PAKOWANIE



Dętki pakowane są w kartony o wymiarach 470x310x310mm

35 kartonów tworzy jedną paletę (1000x1200x1850mm)

26 palet mieści się w naczepie ciężarówki

910 kartonów znajduje się w przyczepie ciężarówki

588 kartonów jest pakowane w kontenerze 20'

W NASZEJ OFERCIE

KABAT

W NASZEJ OFERCIE:

...inny asortyment produkowany przez firmę Kabat:

OPONY ROLNICZE

OPONY PEŁNE

OPONY BIEŻNIKOWANE

MIESZANKI GUMOWE

WYROBY FORMOWE

PROFILE WYTŁACZANE

Więcej informacji na naszej stronie: www.kabat.pl



KABAT

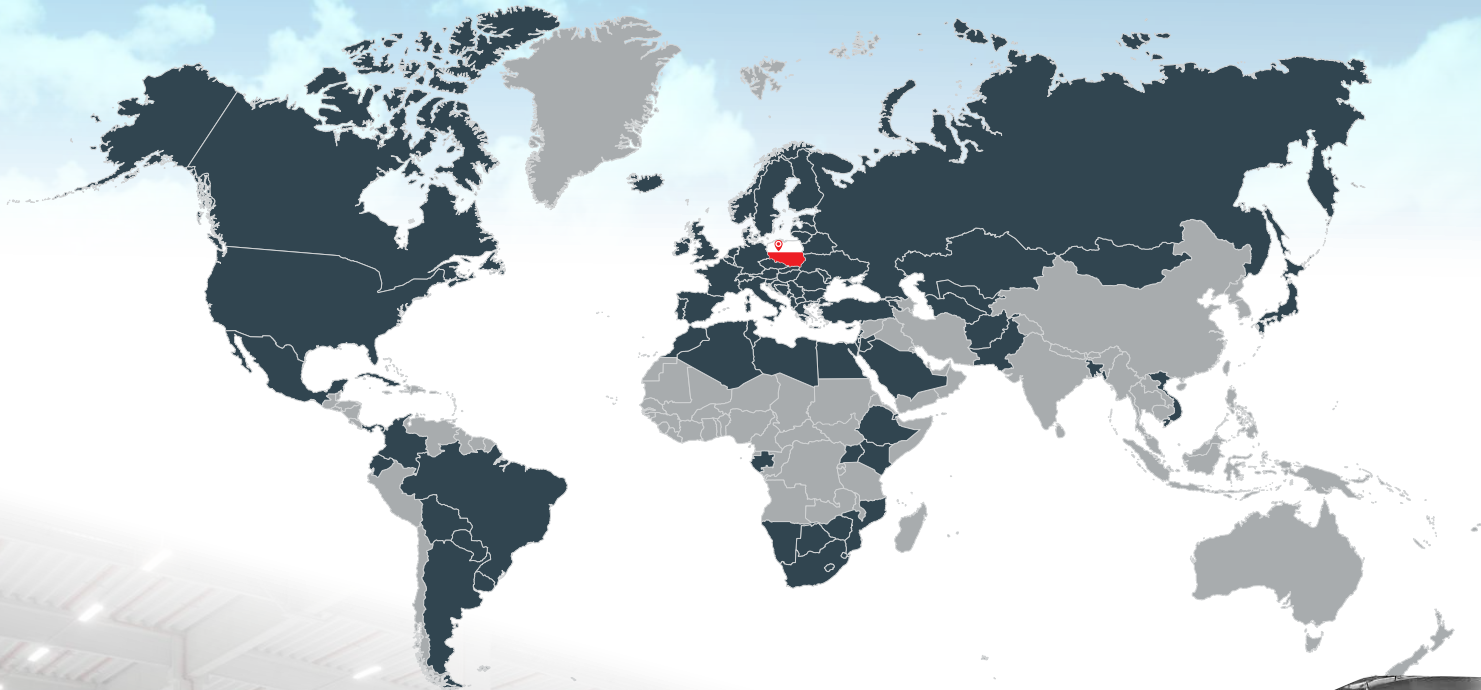

KABAT

www.kabat.pl

KABAT TYRE
spółka z o.o.
64-840 Budzyń
ul. Gumowa 6, POLAND
tel. +48 67 2834 100
e-mail: sprzedaz@kabat.pl

 KABATTYREPOLSKA